



Compact Mixing Unit for Precast Concrete

Tradition in continues evolution



PROJECT AND PRODUCTION BY COMPANY CIACCI MARCO S.R.L., PERUGIA



INTRODUCTION



Compact Mixing Unit

Tradition in continues evolution



PROJECT AND PRODUCTION BY COMPANY CIACCI MARCO S.R.L., PERUGIA

CONSTRUCION CONCEPT OF MIXING UNIT

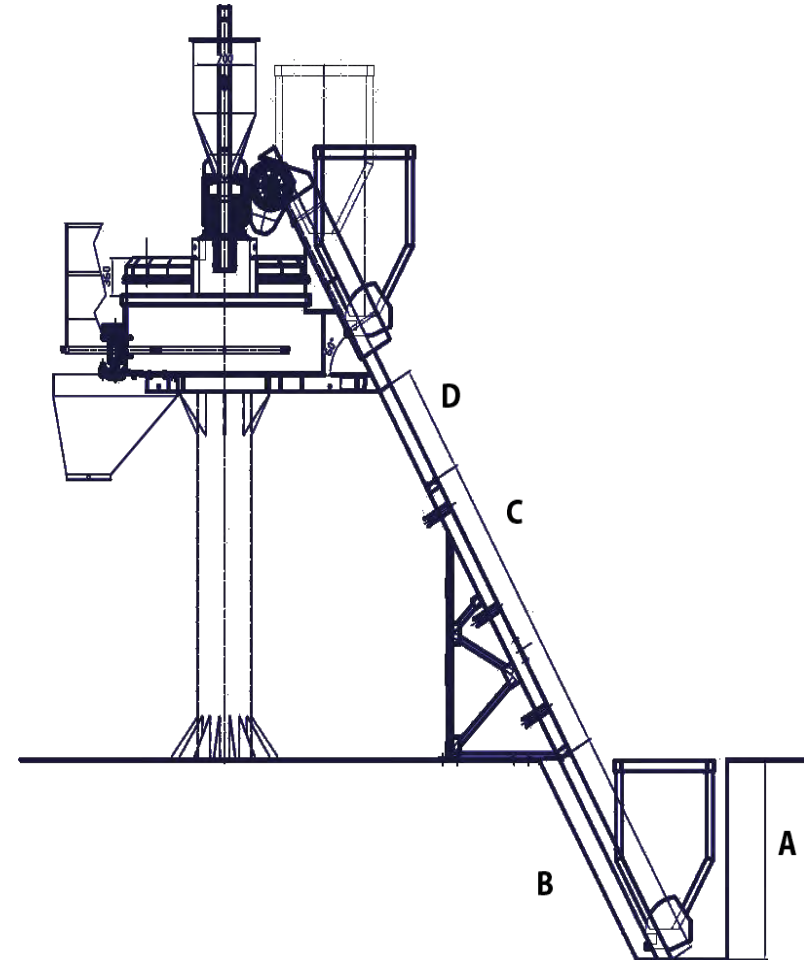



Compact Mixing Unit

Tradition in continues evolution



PROJECT AND PRODUCTION BY COMPANY CIACCI MARCO S.R.L., PERUGIA

CONSTRUCION CONCEPT OF MIXING UNIT

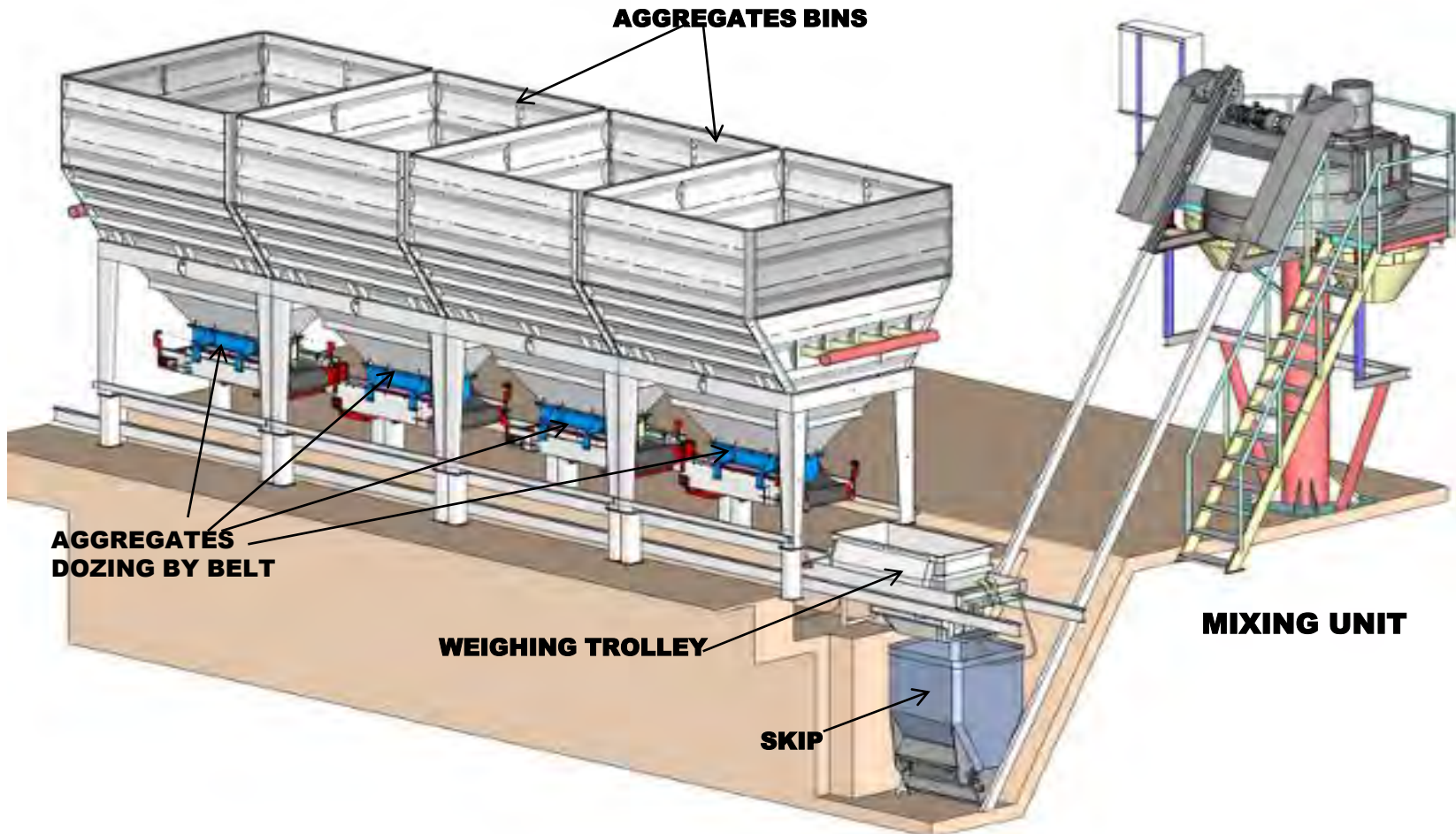



Compact Mixing Unit inside building

Tradition in continues evolution



PROJECT AND PRODUCTION BY COMPANY CIACCI MARCO S.R.L., PERUGIA



Mixer system manufactured by CM for Precast Concrete Batching Plant in Penza, Russia



Compact Mixing Unit outside building



Tradition in continues evolution

PROJECT AND PRODUCTION BY COMPANY CIACCI MARCO S.R.L., PERUGIA



**Aggregates system, Cement Silo manufactured by CM
Outside Concrete Batching Plant in Soumagne, Belgium**



Compact Mixing Unit outside building

Tradition in continues evolution



PROJECT AND PRODUCTION BY COMPANY CIACCI MARCO S.R.L., PERUGIA



**Cement Filter on the ground for the 2 Cement silos
in Salah, Sultanate of Oman**



Compact Mixing Unit

Tradition in continues evolution



PROJECT AND PRODUCTION BY COMPANY CIACCI MARCO S.R.L., PERUGIA



**Pre-assembling inside works for Concrete Batching Plant manufactured by CM
for a client in Manama, Kingdom of Bahrain**



Compact Mixing Unit

Tradition in continues evolution



PROJECT AND PRODUCTION BY COMPANY CIACCI MARCO S.R.L., PERUGIA



Each Concrete Batching Plant is tested inside works after pre-assembling made by CM for a client in Copiapò, Chile



Compact Mixing Unit

Tradition in continues evolution



PROJECT AND PRODUCTION BY COMPANY CIACCI MARCO S.R.L., PERUGIA



Assembling of compact Concrete Batching Plant manufactured by CM of small dimensions for a client in Tbilisi, Georgia



Compact Mixing Unit

Tradition in continues evolution



PROJECT AND PRODUCTION BY COMPANY CIACCI MARCO S.R.L., PERUGIA



Assembling of compact Concrete Batching Plant manufactured by CM of small dimensions for a client in Tripoli, Lybia



Compact Mixing Unit

Tradition in continues evolution



PROJECT AND PRODUCTION BY COMPANY CIACCI MARCO S.R.L., PERUGIA



**AGGREGATES GROUP WITH WEIGHING BELT MADE BY
CM FOR A CLIENT IN DUBAI, U.A.E.**



Compact Mixing Unit

Tradition in continues evolution



PROJECT AND PRODUCTION BY COMPANY CIACCI MARCO S.R.L., PERUGIA



AGGREGATES GROUP WITH WEIGHING TROLLEY MADE BY CM FOR A CLIENT IN CAPCANA, DOMINICAN REPUBLIC



Compact Double Mixing Unit

Tradition in continues evolution



PROJECT AND PRODUCTION BY COMPANY CIACCI MARCO S.R.L., PERUGIA



**MIXING GROUP WITH 2 PLANETARY MIXERS MADE
BY CM FOR A CLIENT IN BERGAMO, ITALY**



Compact Double Mixing Unit

Tradition in continues evolution



PROJECT AND PRODUCTION BY COMPANY CIACCI MARCO S.R.L., PERUGIA



**MIXING GROUP INSIDE BUILDING WITH 2 MIXERS MADE BY
CM FOR A CLIENT IN BERGAMO, ITALY**



Compact Mixing Unit inside building

Tradition in continues evolution



PROJECT AND PRODUCTION BY COMPANY CIACCI MARCO S.R.L., PERUGIA

BATCHING CONCRETE PLANT INSIDE BUILDING MADE BY CM FOR A CLIENT IN BERGAMO, ITALY





Planetary Mixers

Tradition in continues evolution



**PLANETARY MIXER WITH 1 MIXING MOTOR AND
1 MIXING STAR
IDEAL MODEL FOR PRECAST CONCRETE
BATCHING PLANT**



Compact Mixing Unit inside building

Tradition in continues evolution



PROJECT AND PRODUCTION BY COMPANY CIACCI MARCO S.R.L., PERUGIA



Concrete Batching Plant in Germany. Project and Machines manufactured by CM



Compact Mixing Unit inside building

Tradition in continues evolution



PROJECT AND PRODUCTION BY COMPANY CIACCI MARCO S.R.L., PERUGIA

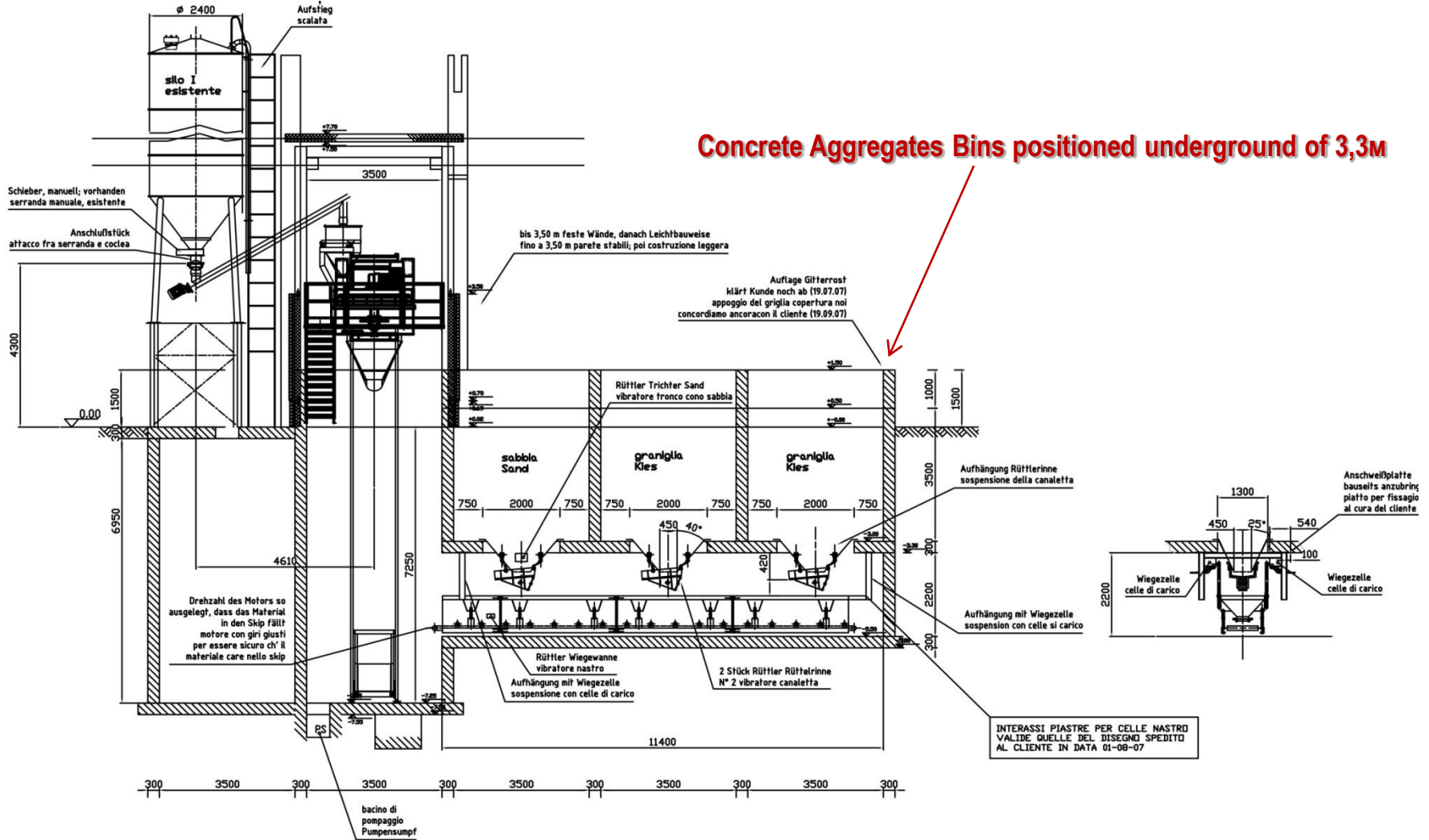

Layout for Concrete Batching Plant in Germany. Project and Machines manufactured by CM



Aggregates storage bins in concrete

Tradition in continues evolution



PROJECT AND PRODUCTION BY COMPANY CIACCI MARCO S.R.L., PERUGIA



**Concrete Batching Plant in Germany. Project and Machines manufactured by CM
Aggregates loading made by truck directly inside bins**



Compact Mixing Unit inside building



Tradition in continues evolution

PROJECT AND PRODUCTION BY COMPANY CIACCI MARCO S.R.L., PERUGIA



**Concrete Batching Plant in Germany. Project and Machines manufactured by CM
Aggregates dozing system made by weighing belt positioned at 5,5m underground quote ± 0**



Compact Mixing Unit inside building

Tradition in continues evolution



PROJECT AND PRODUCTION BY COMPANY CIACCI MARCO S.R.L., PERUGIA



Vibrating drawer for aggregates dozing in Germany



Compact Mixing Unit inside building

Tradition in continues evolution



PROJECT AND PRODUCTION BY COMPANY CIACCI MARCO S.R.L., PERUGIA



Aggregates batch unloaded inside skip in Germany



Compact Mixing Unit outside building



Tradition in continues evolution

PROJECT AND PRODUCTION BY COMPANY CIACCI MARCO S.R.L., PERUGIA



**Concrete Batching Plant with 2 Planetary Mixers in Poland.
Project and Machines manufactured by CM**



Compact Mixing Unit outside building

Tradition in continues evolution



PROJECT AND PRODUCTION BY COMPANY CIACCI MARCO S.R.L., PERUGIA



**Concrete Batching Plant with 2 Planetary Mixers in Poland.
Project and Machines manufactured by CM**



Compact Concrete Plant by CM in Chernivtsi, Ukraine



Mixing System with Planetary Mixer MPC1125/750 and underground Aggregates Bins 24 cbm. each

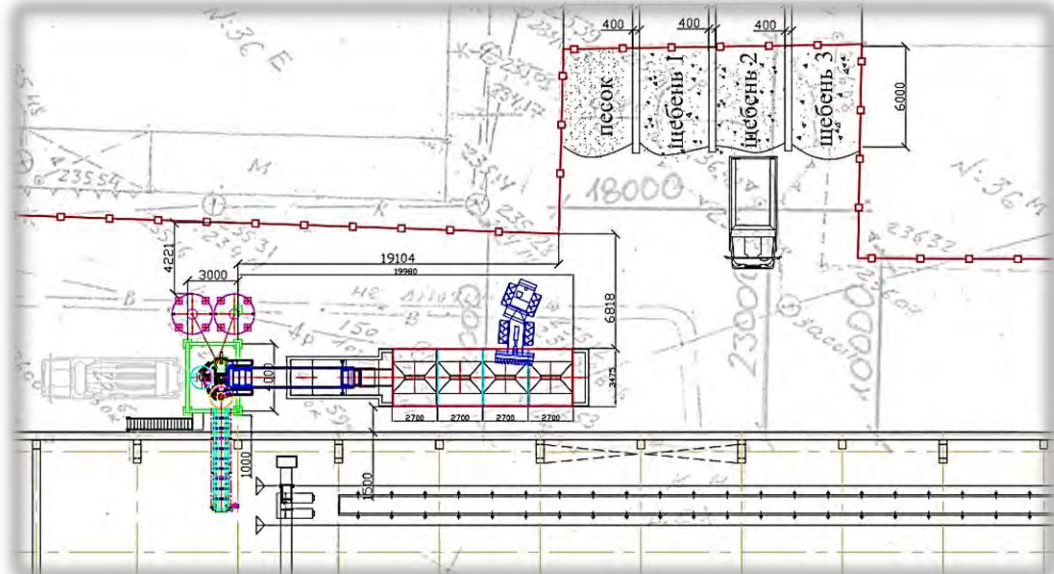
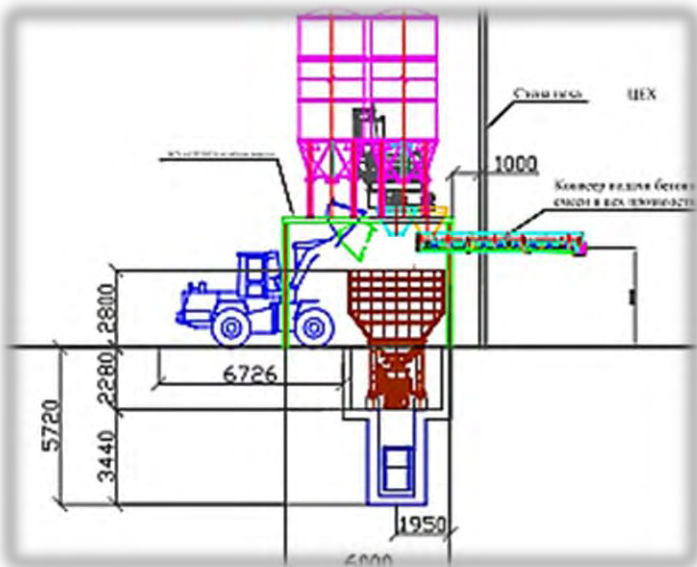
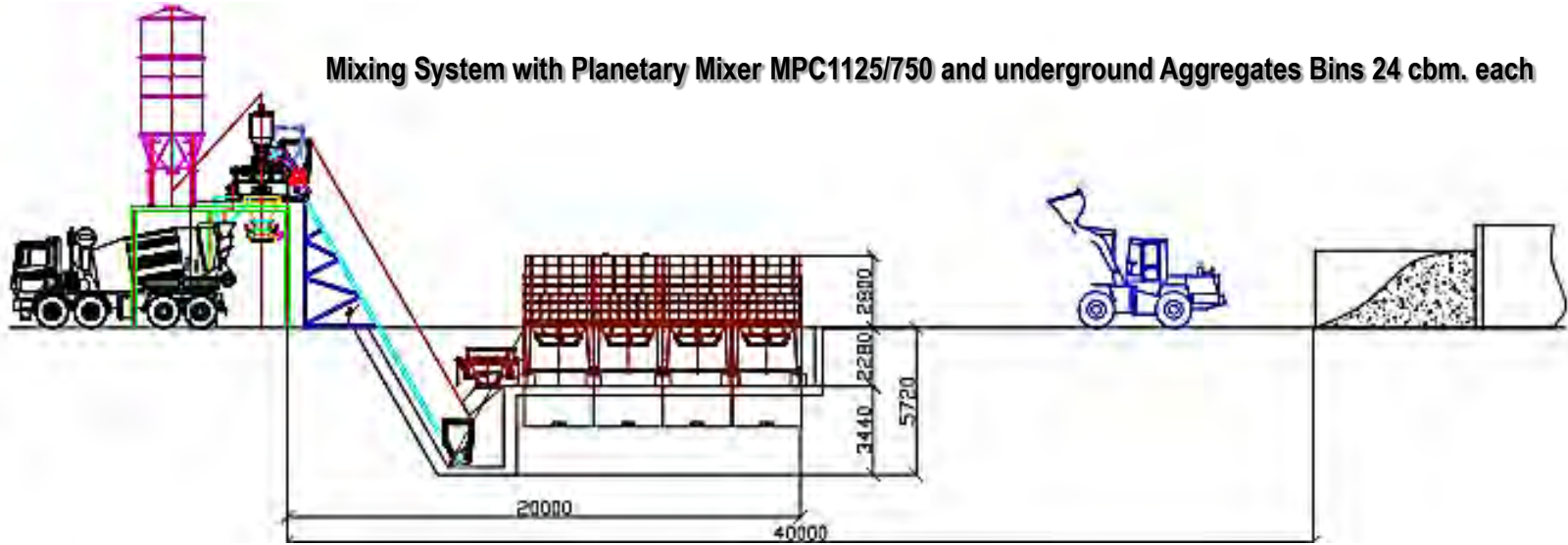



Compact Concrete Plant by CM in Chernivtsi, Ukraine



Project made by CM for a Precast Factory



Loading process over truck for Mixing Plant and Aggregates Storage Bins



Compact Concrete Plant by CM in Chernivtsi, Ukraine



Project made by CM for a Precast Factory



Site preparation process for the entry into service of the Concrete Batching Plant



Concrete Batching Plant with 2 Planetary Mixers and Aggregates Bins 8x31 cbm. each



Project made by **CM** for Concrete Batching Plant in Perugia, Italy





**Aggregates Storage Bins 8x31 cbm. each
with Buckets Elevator for Aggregates Loading**

Project made by **CM** for Concrete Batching Plant in Perugia, Italy





Concrete Batching Plant in Irkutsk, Russia

Project made by CM

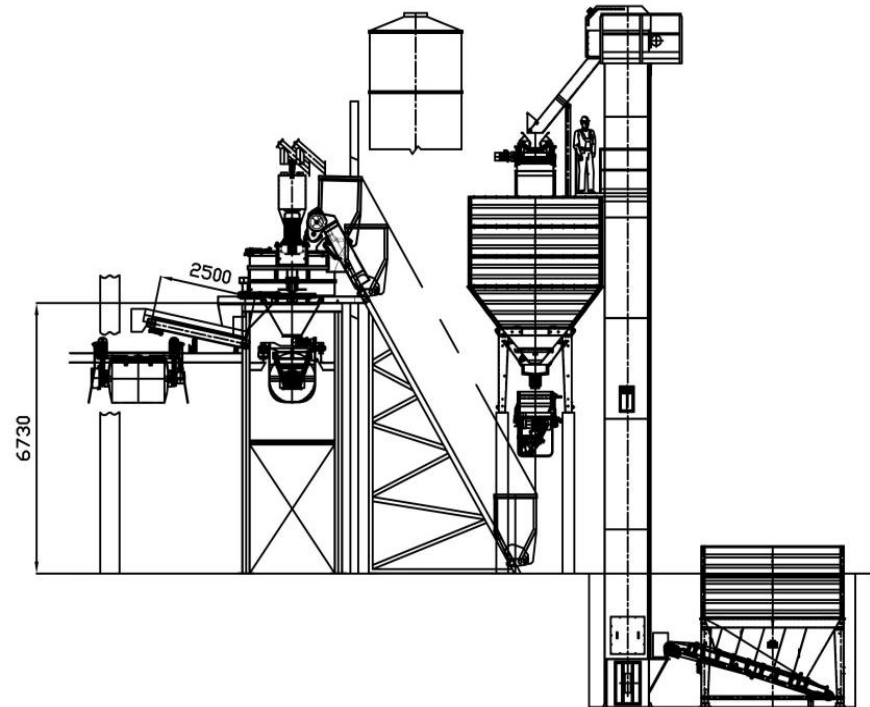
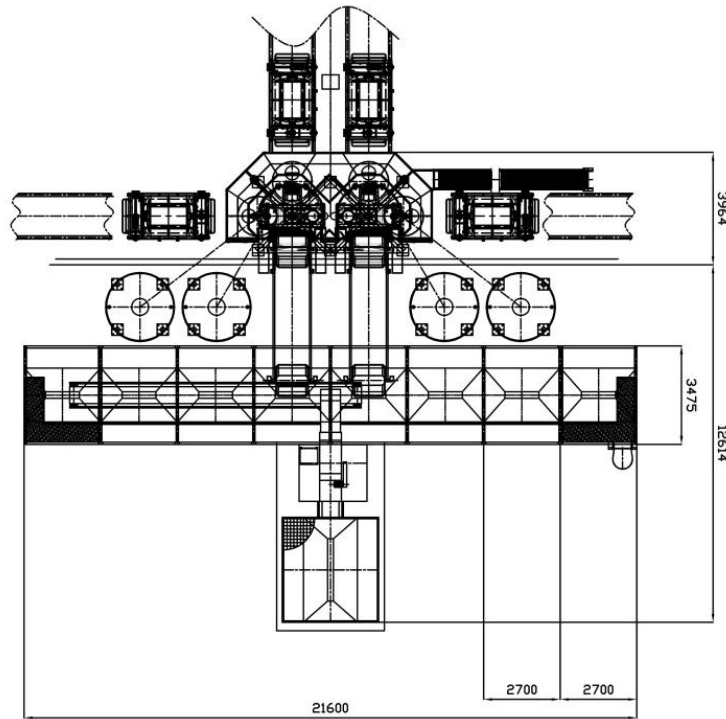

Main components of Concrete Batching Plant:

- Two Mixing Units with 2 Planetary Mixers type MPC 1500/1000
- Aggregates System made of 8 bins of 31 cbm. each. Aggregates Loading by Buckets Elevator
- System for Concrete Distribution for 3 Buildings of 160x24M each and Concrete Distribution for Prestressed Hollow Core Products



Concrete Batching Plant in Irkutsk, Russia

Manufactured and assembled by Company CM





Distribution System for Concrete inside Plant in Irkutsk, Russia



Concrete Transport System by Overhead Tilting Trolley Model VCM 1500 – 2WD made by Company **CM**

Trolley Model HCM 1500 and Concrete Distributor made by Company **CM**



Distribution System for Concrete inside Plant in Irkutsk, Russia



Semiportal Concrete Distributor made by
CM for Prestressed Concrete Product Line

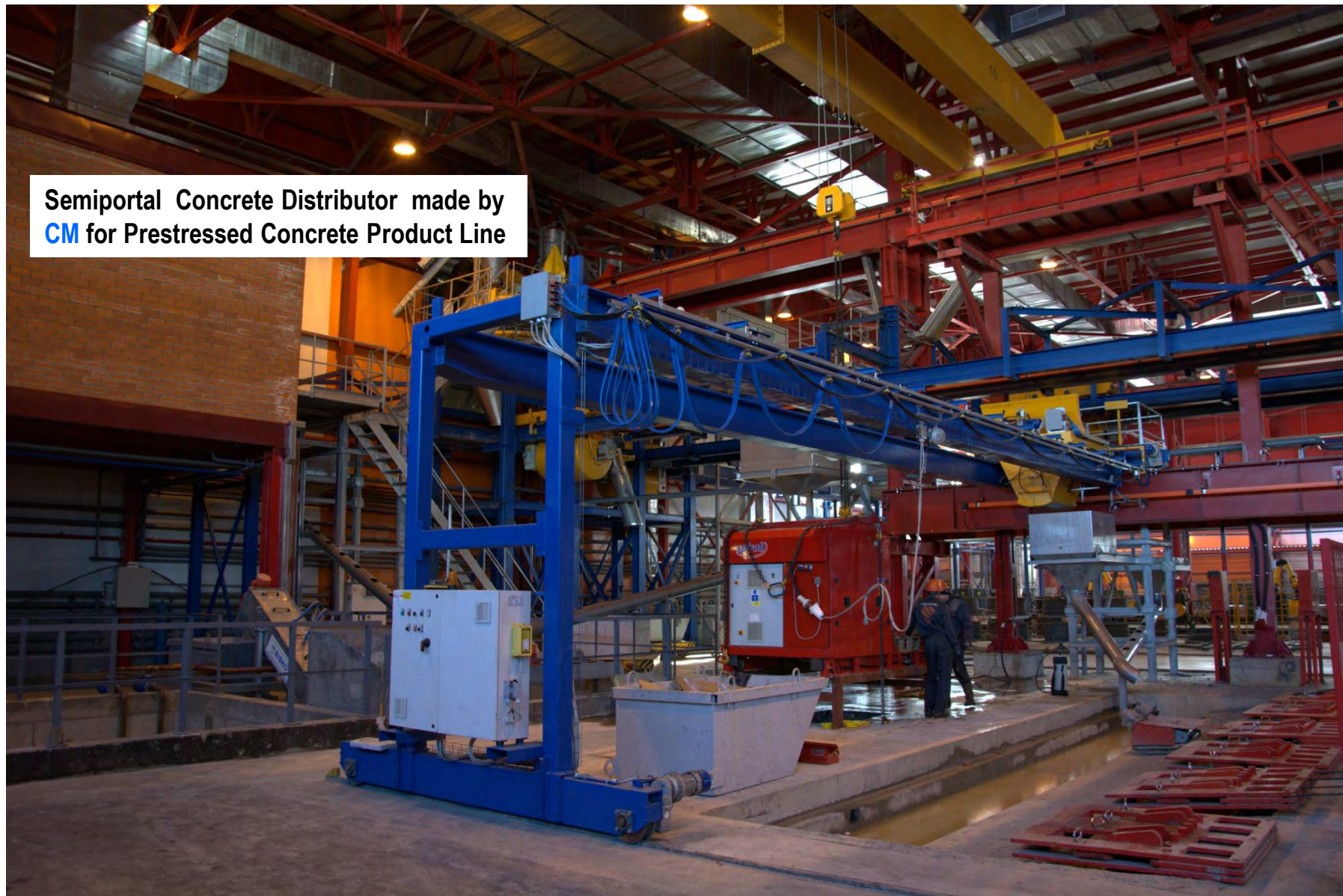



Thank you!

Presentation made by

Stefano Mancini

Sales Director, [CM SRL](#)

Profile: «[Technology for Concrete Industry](#)»

Via della Ghisa, 1 – 06134 Ponte Felcino, Perugia - Italy

Tel/Fax +39 075 527 1911

Email: cmsrl.impianti@gmail.com

Website: www.ciaccimarcosrl.it